









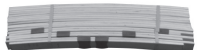

## NOTICE DE MONTAGE SOMKIT 1 PLACE

Retirez avec soin toutes les parties du carton et posez-les sur une surface plate. Vérifiez que tous les éléments ci-dessous sont inclus

REF		DESIGNATION	QTE
A		Rails côtés	2 pcs
B		Rails pieds et tête	2 pcs
C		Lattes	22 pcs
D		Pieds	6 pcs
E		Embouts de lattes	36 pcs
F		Vis	12 pcs
G		Ecrou	12 pcs
H		Rondelle plate	12 pcs
I		Clé Allen	1 pc
J		Clé plate	1 pc

## INSTRUCTIONS DE MONTAGE

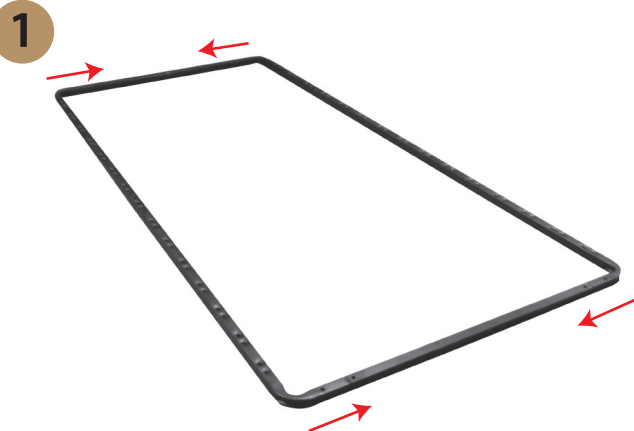

Avec les trous vers le haut, insérez les rail côté (ref A) dans les rails tête et pieds (ref B)



Mettez les embouts de lattes (ref E) sur chaque côté des 22 lattes (ref C)

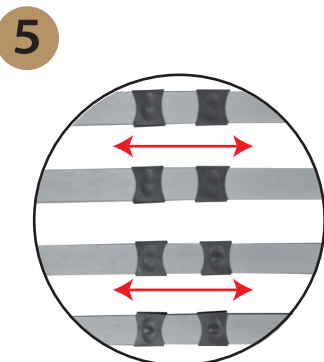

En rapprochant les curseurs noir sur les lattes doubles, vous rendrez la section du milieu plus souple, et en les éloignant, la section du milieu sera plus ferme.

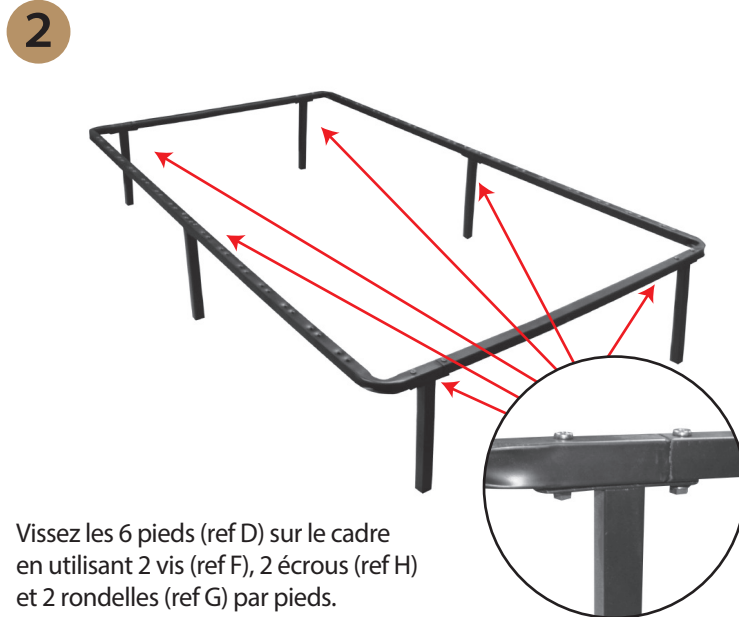

Vissez les 6 pieds (ref D) sur le cadre en utilisant 2 vis (ref F), 2 écrous (ref H) et 2 rondelles (ref G) par pieds. Resserrez en utilisant la clé Allen (ref I) et la clé plate (ref J).

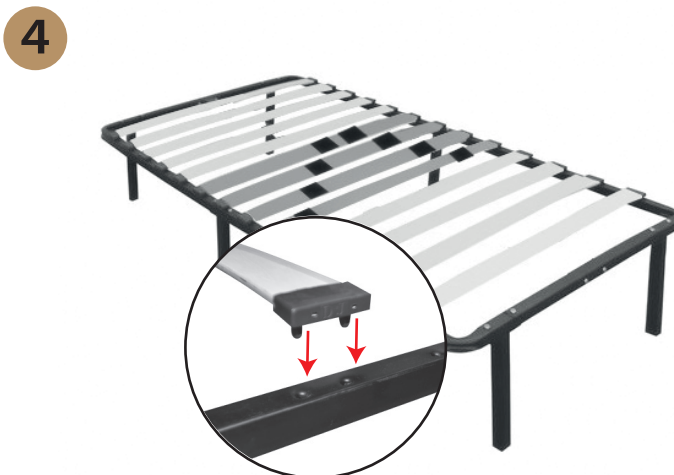

Fixez les lattes au cadre. Les doubles lattes seront installées au milieu.